

Data sheet | Item number: 2020-5317/102-000

3-conductor actuator supply terminal block; for PNP-(high-side) switching actuators; with ground contact; 1 mm²; Push-in CAGE CLAMP®

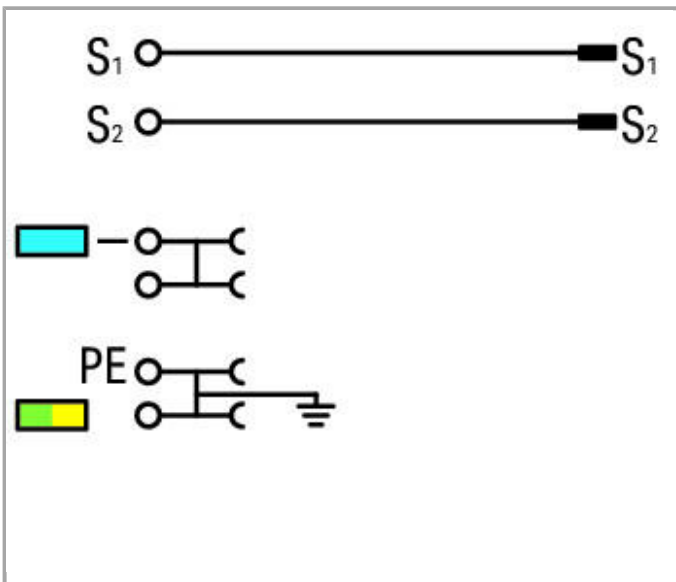

2020-5317/102-000

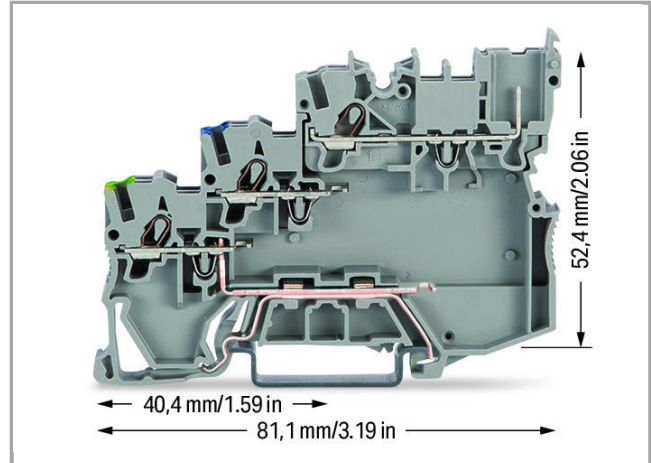
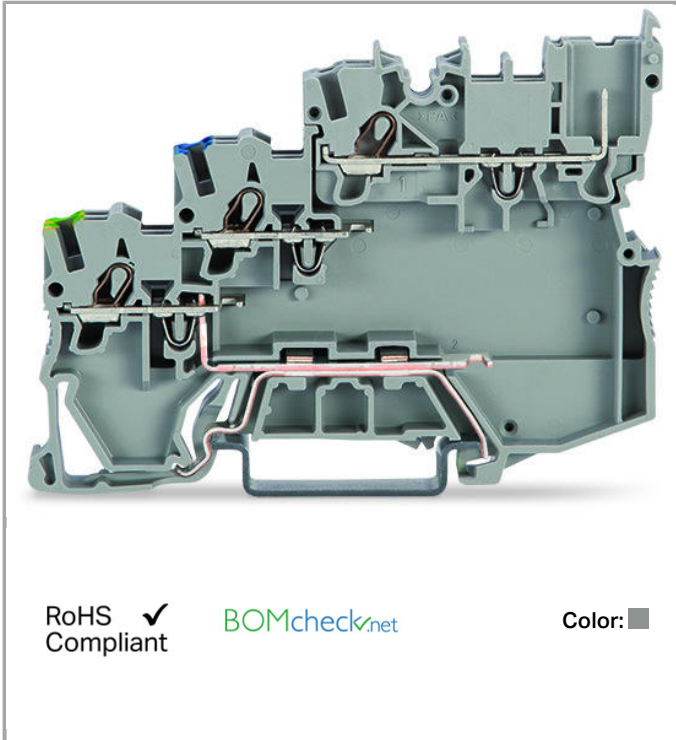

Item description

3.5 mm spacing per signal (2 x 3.5 mm = 7 mm)



The double spacing per pole of this terminal block series maximizes connectivity. For example, ten sensors may be connected using only five sensor terminal blocks plus a power supply terminal block.

Data

Electrical data

Ratings per IEC/EN 60664-1

Rated voltage (III / 3)	250 V
Rated impulse voltage (III / 3)	4 kV
Rated current	13.5 A

Approvals per UL 1059

Rated voltage UL (Use Group B)	300 V
Rated current UL (Use Group B)	15 A
Rated voltage UL (Use Group C)	300 V
Rated current UL (Use Group C)	15 A
Rated voltage UL (Use Group D)	300 V
Rated current UL (Use Group D)	15 A

Approvals per CSA

Rated voltage CSA (Use Group C)	300 V
Rated current CSA (Use Group C)	10 A

Connection data

Connection technology	Push-in CAGE CLAMP®
Actuation type	Push-in Open Tool Slot
Connectable conductor materials	Copper
Nominal cross section	1 mm ²
Solid conductor	0.14 ... 1.5 mm ² / 24 ... 16 AWG
Solid conductor, push-in termination	0.5 ... 1.5 mm ² / 20 ... 16 AWG
Fine-stranded conductor	0.14 ... 1.5 mm ² / 24 ... 16 AWG
Strip length	9 ... 11 mm / 0.35 ... 0.43 inch
Note (conductor cross-section)	Depending on the conductor characteristic, a conductor with a smaller cross section can also be inserted via push-in termination.
Total number of connection points	6
Total number of potentials	4
Type of wiring	Front-entry wiring

Geometrical Data

Width	7 mm / 0.276 inch
Height from upper-edge of DIN-35 rail	52.4 mm / 2.063 inch
Depth	81.1 mm / 3.193 inch

Mechanical data

Design	horizontal
Type of mounting	DIN-35 rail
Marking level	Center/side marking

Material Data

Color	gray
Insulating material	Polyamide 66 (PA 66)
Fire load	0 MJ
Weight	17.376 g

Commercial data

Country of origin	DE
GTIN	4055143523738
Customs Tariff No.	85369010000

Approvals / Certificates

Country specific Approvals







Logo	Approval	Additional Approval Text	Certificate name
	CCA DEKRA Certification B.V.	EN 60947	NTR NL 7617
	CSA DEKRA Certification B.V.	C22.2 No. 158	2516073
	KEMA/KEUR DEKRA Certification B.V.	EN 60947	71- 100670

















UL-Approvals

















Logo	Approval	Additional Approval Text	Certificate name











	UL UL International Germany GmbH	UL 1059	E45172
	UL Underwriters Laboratories Inc.	UL 1059	E45172

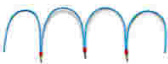









Compatible products













Jumper			
	Item no.: 2000-402 Push-in type jumper bar; insulated; 2-way; Nominal current 14 A		2000-402
	Item no.: 2000-402/000-005 Push-in type jumper bar; insulated; 2-way; Nominal current 14 A	/000-005	2000-402
	Item no.: 2000-402/000-006 Push-in type jumper bar; insulated; 2-way; Nominal current 14 A	/000-006	2000-402
	Item no.: 2000-402/000-018 Push-in type jumper bar; insulated; 2-way; Nominal current 14 A	/000-018	2000-402
	Item no.: 2000-403 Push-in type jumper bar; insulated; 3-way; Nominal current 14 A		2000-403
	Item no.: 2000-403/000-005 Push-in type jumper bar; insulated; 3-way; Nominal current 14 A	/000-005	2000-403
	Item no.: 2000-403/000-006 Push-in type jumper bar; insulated; 3-way; Nominal current 14 A	/000-006	2000-403
	Item no.: 2000-404 Push-in type jumper bar; insulated; 4-way; Nominal current 14 A		2000-404
	Item no.: 2000-404/000-005 Push-in type jumper bar; insulated; 4-way; Nominal current 14 A	/000-005	2000-404









	Item no.: 2000-404/000-006 Push-in type jumper bar; insulated; 4-way; Nominal current 14 A	2000-404
	Item no.: 2000-405 Push-in type jumper bar; insulated; 5-way; Nominal current 14 A	2000-405
	Item no.: 2000-405/000-005 Push-in type jumper bar; insulated; 5-way; Nominal current 14 A	2000-405
	Item no.: 2000-405/000-006 Push-in type jumper bar; insulated; 5-way; Nominal current 14 A	2000-405
	Item no.: 2000-405/011-000 Star point jumper; insulated; 3-way (1-3-5); IN = IN terminal block	2000-405
	Item no.: 2000-406 Push-in type jumper bar; insulated; 6-way; Nominal current 14 A	2000-406
	Item no.: 2000-406/000-005 Push-in type jumper bar; insulated; 6-way; Nominal current 14 A	2000-406
	Item no.: 2000-406/000-006 Push-in type jumper bar; insulated; 6-way; Nominal current 14 A	2000-406
	Item no.: 2000-406/020-000 Delta jumper; insulated; 1-2 3-4 5-6; IN = IN terminal block	2000-406
	Item no.: 2000-407 Push-in type jumper bar; insulated; 7-way; Nominal current 14 A	2000-407
	Item no.: 2000-407/000-005 Push-in type jumper bar; insulated; 7-way; Nominal current 14 A	2000-407
	Item no.: 2000-407/000-006 Push-in type jumper bar; insulated; 7-way; Nominal current 14 A	2000-407
	Item no.: 2000-408 Push-in type jumper bar; insulated; 8-way; Nominal current 14 A	2000-408
	Item no.: 2000-408/000-005 Push-in type jumper bar; insulated; 8-way; Nominal current 14 A	2000-408
	Item no.: 2000-408/000-006 Push-in type jumper bar; insulated; 8-way; Nominal current 14 A	2000-408
	Item no.: 2000-409 Push-in type jumper bar; insulated; 9-way; Nominal current 14 A	2000-409









	Item no.: 2000-409/000-005 Push-in type jumper bar; insulated; 9-way; Nominal current 14 A	2000-409
	Item no.: 2000-409/000-006 Push-in type jumper bar; insulated; 9-way; Nominal current 14 A	2000-409
	Item no.: 2000-410 Push-in type jumper bar; insulated; 10-way; Nominal current 14 A	2000-410
	Item no.: 2000-410/000-005 Push-in type jumper bar; insulated; 10-way; Nominal current 14 A	2000-410
	Item no.: 2000-410/000-006 Push-in type jumper bar; insulated; 10-way; Nominal current 14 A	2000-410
	Item no.: 2000-433 Push-in type jumper bar; insulated; from 1 to 3; Nominal current 14 A	2000-433
	Item no.: 2000-433/000-005 Push-in type jumper bar; insulated; from 1 to 3; Nominal current 14 A	2000-433
	Item no.: 2000-433/000-006 Push-in type jumper bar; insulated; from 1 to 3; Nominal current 14 A	2000-433
	Item no.: 2000-434 Push-in type jumper bar; insulated; from 1 to 4; Nominal current 14 A	2000-434
	Item no.: 2000-435 Push-in type jumper bar; insulated; from 1 to 5; Nominal current 14 A	2000-435
	Item no.: 2000-436 Push-in type jumper bar; insulated; from 1 to 6; Nominal current 14 A	2000-436
	Item no.: 2000-437 Push-in type jumper bar; insulated; from 1 to 7; Nominal current 14 A	2000-437
	Item no.: 2000-438 Push-in type jumper bar; insulated; from 1 to 8; Nominal current 14 A	2000-438
	Item no.: 2000-439 Push-in type jumper bar; insulated; from 1 to 9; Nominal current 14 A	2000-439
	Item no.: 2000-440 Push-in type jumper bar; insulated; from 1 to 10; Nominal current 14 A	2000-440
	Item no.: 2009-402 Push-in type wire jumper; insulated; wire length 60 mm; Conductor cross section 0.75 mm ² ; suitable for 2000 and 2020 Series rail-mounted terminal blocks	2009-402
	Item no.: 2009-404 Push-in type wire jumper; insulated; wire length 110 mm; Conductor cross section 0.75 mm ² ; suitable for 2000 and 2020 Series rail-mounted terminal blocks	2009-404
	Item no.: 2009-406	









	Push-in type wire jumper; insulated; wire length 250 mm; Conductor cross section 0.75 mm ² ; suitable for 2000 and 2020 Series rail-mounted terminal blocks		2009-406
	Item no.: 210-103 Wire commoning chain; insulated; 50 connections		210-103
	Item no.: 210-123 Wire commoning chain; insulated; 50 connections		210-123
End plate			
	Item no.: 2020-5391 End and intermediate plate; 1 mm thick; for 3-conductor terminal blocks	5391	2020-
Protective Warning Marker			
	Item no.: 2000-115 Protective warning marker; with high-voltage symbol, black; for 5 terminal blocks		2000-115
Female plug			
	Item no.: 2020-102 1-conductor female plug; 1.5 mm ² ; 2-pole		2020-102
	Item no.: 2020-102/122-000 1-conductor female plug; Locking lever; 1.5 mm ² ; 2-pole	/ 122-000	2020-102
	Item no.: 2020-102/132-000 1-conductor female plug; Strain relief plate; 1.5 mm ² ; 2-pole	/ 132-000	2020-102
	Item no.: 2020-102/142-000 1-conductor female plug; Strain relief plate; 1.5 mm ² ; 2-pole	/ 142-000	2020-102
	Item no.: 2020-103 1-conductor female plug; 1.5 mm ² ; 3-pole		2020-103
	Item no.: 2020-103/000-036 1-conductor female plug; 1.5 mm ² ; 3-pole	/ 000-036	2020-103
	Item no.: 2020-103/000-037 1-conductor female plug; 1.5 mm ² ; 3-pole	/ 000-037	2020-103
	Item no.: 2020-103/000-038 1-conductor female plug; 1.5 mm ² ; 3-pole	/ 000-038	2020-103
	Item no.: 2020-103/000-039 1-conductor female plug; 1.5 mm ² ; 3-pole	/ 000-039	2020-103
	Item no.: 2020-103/122-000 1-conductor female plug; Locking lever; 1.5 mm ² ; 3-pole	/ 122-000	2020-103









	Item no.: 2020-103/132-000 1-conductor female plug; Strain relief plate; 1.5 mm ² ; 3-pole		2020-103
		/ 132-000	
	Item no.: 2020-103/142-000 1-conductor female plug; Strain relief plate; 1.5 mm ² ; 3-pole		2020-103
		/ 142-000	
	Item no.: 2020-104 1-conductor female plug; 1.5 mm ² ; 4-pole		2020-104
	Item no.: 2020-104/000-036 1-conductor female plug; 1.5 mm ² ; 4-pole	/ 000-036	2020-104
	Item no.: 2020-104/000-037 1-conductor female plug; 1.5 mm ² ; 4-pole	/ 000-037	2020-104
	Item no.: 2020-104/000-038 1-conductor female plug; 1.5 mm ² ; 4-pole	/ 000-038	2020-104
	Item no.: 2020-104/000-039 1-conductor female plug; 1.5 mm ² ; 4-pole	/ 000-039	2020-104
	Item no.: 2020-104/124-000 1-conductor female plug; Locking lever; 1.5 mm ² ; 4-pole		2020-104
		/ 124-000	
	Item no.: 2020-104/133-000 1-conductor female plug; Strain relief plate; 1.5 mm ² ; 4-pole		2020-104
		/ 133-000	
	Item no.: 2020-104/143-000 1-conductor female plug; Strain relief plate; 1.5 mm ² ; 4-pole		2020-104
		/ 143-000	
	Item no.: 2020-105 1-conductor female plug; 1.5 mm ² ; 5-pole		2020-105
	Item no.: 2020-105/000-036 1-conductor female plug; 1.5 mm ² ; 5-pole	/ 000-036	2020-105
	Item no.: 2020-105/000-037 1-conductor female plug; 1.5 mm ² ; 5-pole	/ 000-037	2020-105
	Item no.: 2020-105/000-038 1-conductor female plug; 1.5 mm ² ; 5-pole	/ 000-038	2020-105
	Item no.: 2020-105/000-039 1-conductor female plug; 1.5 mm ² ; 5-pole	/ 000-039	2020-105













	Item no.: 2020-105/124-000 1-conductor female plug; Locking lever; 1.5 mm ² ; 5-pole	/ 124-000	2020-105
	Item no.: 2020-105/133-000 1-conductor female plug; Strain relief plate; 1.5 mm ² ; 5-pole	/ 133-000	2020-105
	Item no.: 2020-105/143-000 1-conductor female plug; Strain relief plate; 1.5 mm ² ; 5-pole	/ 143-000	2020-105
	Item no.: 2020-106 1-conductor female plug; 1.5 mm ² ; 6-pole		2020-106
	Item no.: 2020-106/000-036 1-conductor female plug; 1.5 mm ² ; 6-pole	/ 000-036	2020-106
	Item no.: 2020-106/000-037 1-conductor female plug; 1.5 mm ² ; 6-pole	/ 000-037	2020-106
	Item no.: 2020-106/000-038 1-conductor female plug; 1.5 mm ² ; 6-pole	/ 000-038	2020-106
	Item no.: 2020-106/000-039 1-conductor female plug; 1.5 mm ² ; 6-pole	/ 000-039	2020-106
	Item no.: 2020-106/124-000 1-conductor female plug; Locking lever; 1.5 mm ² ; 6-pole	/ 124-000	2020-106
	Item no.: 2020-106/133-000 1-conductor female plug; Strain relief plate; 1.5 mm ² ; 6-pole	/ 133-000	2020-106
	Item no.: 2020-106/143-000 1-conductor female plug; Strain relief plate; 1.5 mm ² ; 6-pole	/ 143-000	2020-106
	Item no.: 2020-107 1-conductor female plug; 1.5 mm ² ; 7-pole		2020-107
	Item no.: 2020-107/000-036 1-conductor female plug; 1.5 mm ² ; 7-pole	/ 000-036	2020-107
	Item no.: 2020-107/000-037 1-conductor female plug; 1.5 mm ² ; 7-pole	/ 000-037	2020-107
	Item no.: 2020-107/000-038 1-conductor female plug; 1.5 mm ² ; 7-pole	/ 000-038	2020-107















	Item no.: 2020-107/000-039 1-conductor female plug; 1.5 mm ² ; 7-pole	/000-039	2020-107
	Item no.: 2020-107/124-000 1-conductor female plug; Locking lever; 1.5 mm ² ; 7-pole	/124-000	2020-107
	Item no.: 2020-107/134-000 1-conductor female plug; Strain relief plate; 1.5 mm ² ; 7-pole	/134-000	2020-107
	Item no.: 2020-107/144-000 1-conductor female plug; Strain relief plate; 1.5 mm ² ; 7-pole	/144-000	2020-107
	Item no.: 2020-108 1-conductor female plug; 1.5 mm ² ; 8-pole		2020-108
	Item no.: 2020-108/000-036 1-conductor female plug; 1.5 mm ² ; 8-pole	/000-036	2020-108
	Item no.: 2020-108/000-037 1-conductor female plug; 1.5 mm ² ; 8-pole	/000-037	2020-108
	Item no.: 2020-108/000-038 1-conductor female plug; 1.5 mm ² ; 8-pole	/000-038	2020-108
	Item no.: 2020-108/000-039 1-conductor female plug; 1.5 mm ² ; 8-pole	/000-039	2020-108
	Item no.: 2020-108/124-000 1-conductor female plug; Locking lever; 1.5 mm ² ; 8-pole	/124-000	2020-108
	Item no.: 2020-108/134-000 1-conductor female plug; Strain relief plate; 1.5 mm ² ; 8-pole	/134-000	2020-108
	Item no.: 2020-108/144-000 1-conductor female plug; Strain relief plate; 1.5 mm ² ; 8-pole	/144-000	2020-108
	Item no.: 2020-109 1-conductor female plug; 1.5 mm ² ; 9-pole		2020-109
	Item no.: 2020-109/000-036 1-conductor female plug; 1.5 mm ² ; 9-pole	/000-036	2020-109
	Item no.: 2020-109/000-037 1-conductor female plug; 1.5 mm ² ; 9-pole	/000-037	2020-109















	Item no.: 2020-109/000-038 1-conductor female plug; 1.5 mm ² ; 9-pole	/000-038	2020-109
	Item no.: 2020-109/000-039 1-conductor female plug; 1.5 mm ² ; 9-pole	/000-039	2020-109
	Item no.: 2020-109/124-000 1-conductor female plug; Locking lever; 1.5 mm ² ; 9-pole	/124-000	2020-109
	Item no.: 2020-109/134-000 1-conductor female plug; Strain relief plate; 1.5 mm ² ; 9-pole	/134-000	2020-109
	Item no.: 2020-109/144-000 1-conductor female plug; Strain relief plate; 1.5 mm ² ; 9-pole	/144-000	2020-109
	Item no.: 2020-110 1-conductor female plug; 1.5 mm ² ; 10-pole		2020-110
	Item no.: 2020-110/000-036 1-conductor female plug; 1.5 mm ² ; 10-pole	/000-036	2020-110
	Item no.: 2020-110/000-037 1-conductor female plug; 1.5 mm ² ; 10-pole	/000-037	2020-110
	Item no.: 2020-110/000-038 1-conductor female plug; 1.5 mm ² ; 10-pole	/000-038	2020-110
	Item no.: 2020-110/000-039 1-conductor female plug; 1.5 mm ² ; 10-pole	/000-039	2020-110
	Item no.: 2020-110/125-000 1-conductor female plug; Locking lever; 1.5 mm ² ; 10-pole	/125-000	2020-110
	Item no.: 2020-110/135-000 1-conductor female plug; Strain relief plate; 1.5 mm ² ; 10-pole	/135-000	2020-110
	Item no.: 2020-110/145-000 1-conductor female plug; Strain relief plate; 1.5 mm ² ; 10-pole	/145-000	2020-110
	Item no.: 2020-111 1-conductor female plug; 1.5 mm ² ; 11-pole		2020-111
	Item no.: 2020-111/000-036 1-conductor female plug; 1.5 mm ² ; 11-pole	/000-036	2020-111

	Item no.: 2020-111/000-037 1-conductor female plug; 1.5 mm ² ; 11-pole	/000-037	2020-111
	Item no.: 2020-111/000-038 1-conductor female plug; 1.5 mm ² ; 11-pole	/000-038	2020-111
	Item no.: 2020-111/000-039 1-conductor female plug; 1.5 mm ² ; 11-pole	/000-039	2020-111
	Item no.: 2020-111/125-000 1-conductor female plug; Locking lever; 1.5 mm ² ; 11-pole	/125-000	2020-111
	Item no.: 2020-111/135-000 1-conductor female plug; Strain relief plate; 1.5 mm ² ; 11-pole	/135-000	2020-111
	Item no.: 2020-111/145-000 1-conductor female plug; Strain relief plate; 1.5 mm ² ; 11-pole	/145-000	2020-111
	Item no.: 2020-112 1-conductor female plug; 1.5 mm ² ; 12-pole		2020-112
	Item no.: 2020-112/000-036 1-conductor female plug; 1.5 mm ² ; 12-pole	/000-036	2020-112
	Item no.: 2020-112/000-037 1-conductor female plug; 1.5 mm ² ; 12-pole	/000-037	2020-112
	Item no.: 2020-112/000-038 1-conductor female plug; 1.5 mm ² ; 12-pole	/000-038	2020-112
	Item no.: 2020-112/000-039 1-conductor female plug; 1.5 mm ² ; 12-pole	/000-039	2020-112
	Item no.: 2020-112/125-000 1-conductor female plug; Locking lever; 1.5 mm ² ; 12-pole	/125-000	2020-112
	Item no.: 2020-112/135-000 1-conductor female plug; Strain relief plate; 1.5 mm ² ; 12-pole	/135-000	2020-112
	Item no.: 2020-112/145-000 1-conductor female plug; Strain relief plate; 1.5 mm ² ; 12-pole	/145-000	2020-112
	Item no.: 2020-113 1-conductor female plug; 1.5 mm ² ; 13-pole		2020-113















	Item no.: 2020-113/000-036 1-conductor female plug; 1.5 mm²; 13-pole	/000-036	2020-113
	Item no.: 2020-113/000-037 1-conductor female plug; 1.5 mm²; 13-pole	/000-037	2020-113
	Item no.: 2020-113/000-038 1-conductor female plug; 1.5 mm²; 13-pole	/000-038	2020-113
	Item no.: 2020-113/000-039 1-conductor female plug; 1.5 mm²; 13-pole	/000-039	2020-113
	Item no.: 2020-113/125-000 1-conductor female plug; Locking lever; 1.5 mm²; 13-pole	/125-000	2020-113
	Item no.: 2020-113/135-000 1-conductor female plug; Strain relief plate; 1.5 mm²; 13-pole	/135-000	2020-113
	Item no.: 2020-113/145-000 1-conductor female plug; Strain relief plate; 1.5 mm²; 13-pole	/145-000	2020-113
	Item no.: 2020-114 1-conductor female plug; 1.5 mm²; 14-pole		2020-114
	Item no.: 2020-114/000-036 1-conductor female plug; 1.5 mm²; 14-pole	/000-036	2020-114
	Item no.: 2020-114/000-037 1-conductor female plug; 1.5 mm²; 14-pole	/000-037	2020-114
	Item no.: 2020-114/000-038 1-conductor female plug; 1.5 mm²; 14-pole	/000-038	2020-114
	Item no.: 2020-114/000-039 1-conductor female plug; 1.5 mm²; 14-pole	/000-039	2020-114
	Item no.: 2020-114/125-000 1-conductor female plug; Locking lever; 1.5 mm²; 14-pole	/125-000	2020-114
	Item no.: 2020-114/135-000 1-conductor female plug; Strain relief plate; 1.5 mm²; 14-pole	/135-000	2020-114
	Item no.: 2020-114/145-000 1-conductor female plug; Strain relief plate; 1.5 mm²; 14-pole	/145-000	2020-114















	Item no.: 2020-115 1-conductor female plug; 1.5 mm ² ; 15-pole		2020-115
	Item no.: 2020-115/000-036 1-conductor female plug; 1.5 mm ² ; 15-pole	/000-036	2020-115
	Item no.: 2020-115/000-037 1-conductor female plug; 1.5 mm ² ; 15-pole	/000-037	2020-115
	Item no.: 2020-115/000-038 1-conductor female plug; 1.5 mm ² ; 15-pole	/000-038	2020-115
	Item no.: 2020-115/000-039 1-conductor female plug; 1.5 mm ² ; 15-pole	/000-039	2020-115
	Item no.: 2020-115/125-000 1-conductor female plug; Locking lever; 1.5 mm ² ; 15-pole	/125-000	2020-115
	Item no.: 2020-115/135-000 1-conductor female plug; Strain relief plate; 1.5 mm ² ; 15-pole	/135-000	2020-115
	Item no.: 2020-115/145-000 1-conductor female plug; Strain relief plate; 1.5 mm ² ; 15-pole	/145-000	2020-115
	Item no.: 2020-202 2-conductor female connector; 1.5 mm ² ; 2-pole		2020-202
	Item no.: 2020-203 2-conductor female connector; 1.5 mm ² ; 3-pole		2020-203
	Item no.: 2020-203/000-036 2-conductor female connector; 1.5 mm ² ; 3-pole	/000-036	2020-203
	Item no.: 2020-203/000-037 2-conductor female connector; 1.5 mm ² ; 3-pole	/000-037	2020-203
	Item no.: 2020-203/000-038 2-conductor female connector; 1.5 mm ² ; 3-pole	/000-038	2020-203
	Item no.: 2020-203/000-039 2-conductor female connector; 1.5 mm ² ; 3-pole	/000-039	2020-203
	Item no.: 2020-204 2-conductor female connector; 1.5 mm ² ; 4-pole		2020-204
	Item no.: 2020-204/000-036 2-conductor female connector; 1.5 mm ² ; 4-pole	/000-036	2020-204

	Item no.: 2020-204/000-037 2-conductor female connector; 1.5 mm²; 4-pole	/000-037	2020-204
	Item no.: 2020-204/000-038 2-conductor female connector; 1.5 mm²; 4-pole	/000-038	2020-204
	Item no.: 2020-204/000-039 2-conductor female connector; 1.5 mm²; 4-pole	/000-039	2020-204
	Item no.: 2020-205 2-conductor female connector; 1.5 mm²; 5-pole		2020-205
	Item no.: 2020-205/000-036 2-conductor female connector; 1.5 mm²; 5-pole	/000-036	2020-205
	Item no.: 2020-205/000-037 2-conductor female connector; 1.5 mm²; 5-pole	/000-037	2020-205
	Item no.: 2020-205/000-038 2-conductor female connector; 1.5 mm²; 5-pole	/000-038	2020-205
	Item no.: 2020-205/000-039 2-conductor female connector; 1.5 mm²; 5-pole	/000-039	2020-205
	Item no.: 2020-206 2-conductor female connector; 1.5 mm²; 6-pole		2020-206
	Item no.: 2020-206/000-036 2-conductor female connector; 1.5 mm²; 6-pole	/000-036	2020-206
	Item no.: 2020-206/000-037 2-conductor female connector; 1.5 mm²; 6-pole	/000-037	2020-206
	Item no.: 2020-206/000-038 2-conductor female connector; 1.5 mm²; 6-pole	/000-038	2020-206
	Item no.: 2020-206/000-039 2-conductor female connector; 1.5 mm²; 6-pole	/000-039	2020-206
	Item no.: 2020-207 2-conductor female connector; 1.5 mm²; 7-pole		2020-207
	Item no.: 2020-207/000-036 2-conductor female connector; 1.5 mm²; 7-pole	/000-036	2020-207

















	Item no.: 2020-207/000-037 2-conductor female connector; 1.5 mm²; 7-pole	/000-037	2020-207
	Item no.: 2020-207/000-038 2-conductor female connector; 1.5 mm²; 7-pole	/000-038	2020-207
	Item no.: 2020-207/000-039 2-conductor female connector; 1.5 mm²; 7-pole	/000-039	2020-207
	Item no.: 2020-208 2-conductor female connector; 1.5 mm²; 8-pole		2020-208
	Item no.: 2020-208/000-036 2-conductor female connector; 1.5 mm²; 8-pole	/000-036	2020-208
	Item no.: 2020-208/000-037 2-conductor female connector; 1.5 mm²; 8-pole	/000-037	2020-208
	Item no.: 2020-208/000-038 2-conductor female connector; 1.5 mm²; 8-pole	/000-038	2020-208
	Item no.: 2020-208/000-039 2-conductor female connector; 1.5 mm²; 8-pole	/000-039	2020-208
	Item no.: 2020-209 2-conductor female connector; 1.5 mm²; 9-pole		2020-209
	Item no.: 2020-209/000-036 2-conductor female connector; 1.5 mm²; 9-pole	/000-036	2020-209
	Item no.: 2020-209/000-037 2-conductor female connector; 1.5 mm²; 9-pole	/000-037	2020-209
	Item no.: 2020-209/000-038 2-conductor female connector; 1.5 mm²; 9-pole	/000-038	2020-209
	Item no.: 2020-209/000-039 2-conductor female connector; 1.5 mm²; 9-pole	/000-039	2020-209
	Item no.: 2020-210 2-conductor female connector; 1.5 mm²; 10-pole		2020-210
	Item no.: 2020-210/000-036 2-conductor female connector; 1.5 mm²; 10-pole	/000-036	2020-210
	Item no.: 2020-210/000-037 2-conductor female connector; 1.5 mm²; 10-pole	/000-037	2020-210





















	Item no.: 2020-210/000-038 2-conductor female connector; 1.5 mm ² ; 10-pole	/000-038	2020-210
	Item no.: 2020-210/000-039 2-conductor female connector; 1.5 mm ² ; 10-pole	/000-039	2020-210
	Item no.: 2020-211 2-conductor female connector; 1.5 mm ² ; 11-pole		2020-211
	Item no.: 2020-211/000-036 2-conductor female connector; 1.5 mm ² ; 11-pole	/000-036	2020-211
	Item no.: 2020-211/000-037 2-conductor female connector; 1.5 mm ² ; 11-pole	/000-037	2020-211
	Item no.: 2020-211/000-038 2-conductor female connector; 1.5 mm ² ; 11-pole	/000-038	2020-211
	Item no.: 2020-211/000-039 2-conductor female connector; 1.5 mm ² ; 11-pole	/000-039	2020-211
	Item no.: 2020-212 2-conductor female connector; 1.5 mm ² ; 12-pole		2020-212
	Item no.: 2020-212/000-036 2-conductor female connector; 1.5 mm ² ; 12-pole	/000-036	2020-212
	Item no.: 2020-212/000-037 2-conductor female connector; 1.5 mm ² ; 12-pole	/000-037	2020-212
	Item no.: 2020-212/000-038 2-conductor female connector; 1.5 mm ² ; 12-pole	/000-038	2020-212
	Item no.: 2020-212/000-039 2-conductor female connector; 1.5 mm ² ; 12-pole	/000-039	2020-212
	Item no.: 2020-213 2-conductor female connector; 1.5 mm ² ; 13-pole		2020-213
	Item no.: 2020-213/000-036 2-conductor female connector; 1.5 mm ² ; 13-pole	/000-036	2020-213
	Item no.: 2020-213/000-037 2-conductor female connector; 1.5 mm ² ; 13-pole	/000-037	2020-213

	Item no.: 2020-213/000-038 2-conductor female connector; 1.5 mm²; 13-pole	/000-038	2020-213
	Item no.: 2020-213/000-039 2-conductor female connector; 1.5 mm²; 13-pole	/000-039	2020-213
	Item no.: 2020-214 2-conductor female connector; 1.5 mm²; 14-pole		2020-214
	Item no.: 2020-214/000-036 2-conductor female connector; 1.5 mm²; 14-pole	/000-036	2020-214
	Item no.: 2020-214/000-037 2-conductor female connector; 1.5 mm²; 14-pole	/000-037	2020-214
	Item no.: 2020-214/000-038 2-conductor female connector; 1.5 mm²; 14-pole	/000-038	2020-214
	Item no.: 2020-214/000-039 2-conductor female connector; 1.5 mm²; 14-pole	/000-039	2020-214
	Item no.: 2020-215 2-conductor female connector; 1.5 mm²; 15-pole		2020-215
	Item no.: 2020-215/000-036 2-conductor female connector; 1.5 mm²; 15-pole	/000-036	2020-215
	Item no.: 2020-215/000-037 2-conductor female connector; 1.5 mm²; 15-pole	/000-037	2020-215
	Item no.: 2020-215/000-038 2-conductor female connector; 1.5 mm²; 15-pole	/000-038	2020-215
	Item no.: 2020-215/000-039 2-conductor female connector; 1.5 mm²; 15-pole	/000-039	2020-215
tools			
	Item no.: 210-647 Operating tool with partially insulated shaft; Blade (2.5 x 0.4) mm; short		210-647
	Item no.: 210-648 Operating tool with partially insulated shaft; Blade (2.5 x 0.4) mm; short; angled		210-648
	Item no.: 210-719 Operating tool with partially insulated shaft; Type 1, blade (2.5 x 0.4) mm		210-719

Marking accessories

	Item no.: 2009-110 Marking strips; on reel; not stretchable; plain; snap-on type	2009-110
	Item no.: 2009-113 WMB-Inline; for Smart Printer; on reel; plain; snap-on type	2009-113
	Item no.: 2009-113/000-002 WMB-Inline; for Smart Printer; on reel; plain; snap-on type	2009-113 /000-002
	Item no.: 2009-113/000-005 WMB-Inline; for Smart Printer; on reel; plain; snap-on type	2009-113 /000-005
	Item no.: 2009-113/000-006 WMB-Inline; for Smart Printer; on reel; plain; snap-on type	2009-113 /000-006
	Item no.: 2009-113/000-007 WMB-Inline; for Smart Printer; on reel; plain; snap-on type	2009-113 /000-007
	Item no.: 2009-113/000-012 WMB-Inline; for Smart Printer; on reel; plain; snap-on type	2009-113 /000-012
	Item no.: 2009-113/000-017 WMB-Inline; for Smart Printer; on reel; plain; snap-on type	2009-113 /000-017
	Item no.: 2009-113/000-023 WMB-Inline; for Smart Printer; on reel; plain; snap-on type	2009-113 /000-023
	Item no.: 2009-113/000-024 WMB-Inline; for Smart Printer; on reel; plain; snap-on type	2009-113 /000-024
	Item no.: 2009-191 Group marker carrier	2009-191
	Item no.: 793-3501 WMB marking card; as card; plain; snap-on type	793-3501
Carrier rail		
	Item no.: 210-112 Steel carrier rail; 35 x 7.5 mm; 1 mm thick; 2 m long; slotted; according to EN 60715; "Hole width 25 mm	210-112
	Item no.: 210-113 Steel carrier rail; 35 x 7.5 mm; 1 mm thick; 2 m long; unslotted; according to EN 60715	210-113
	Item no.: 210-114 Steel carrier rail; 35 x 15 mm; 1.5 mm thick; 2 m long; unslotted; similar to EN 60715	210-114
	Item no.: 210-115 Steel carrier rail; 35 x 7.5 mm; 1 mm thick; 2 m long; slotted; according to EN 60715; "Hole width 18 mm	210-115

	Item no.: 210-118 Steel carrier rail; 35 x 15 mm; 2.3 mm thick; 2 m long; unslotted; according to EN 60715	210-118
	Item no.: 210-196 Aluminum carrier rail; 35 x 8.2 mm; 1.6 mm thick; 2 m long; unslotted; similar to EN 60715	210-196
	Item no.: 210-197 Steel carrier rail; 35 x 15 mm; 1.5 mm thick; 2 m long; slotted; similar to EN 60715	210-197
	Item no.: 210-198 Copper carrier rail; 35 x 15 mm; 2.3 mm thick; 2 m long; unslotted; according to EN 60715	210-198
check		
	Item no.: 2000-510 TOPJOB®S L-type test plug module; modular; for jumper contact slot	2000-510
	Item no.: 2000-552 Modular TOPJOB®S connector; modular; for jumper contact slot; 2-pole	2000-552
	Item no.: 2000-553 Modular TOPJOB®S connector; modular; for jumper contact slot; 3-pole	2000-553
	Item no.: 2000-554 Modular TOPJOB®S connector; modular; for jumper contact slot; 4-pole	2000-554
	Item no.: 2000-555 Modular TOPJOB®S connector; modular; for jumper contact slot; 5-pole	2000-555
	Item no.: 2000-556 Modular TOPJOB®S connector; modular; for jumper contact slot; 6-pole	2000-556
	Item no.: 2000-557 Modular TOPJOB®S connector; modular; for jumper contact slot; 7-pole	2000-557
	Item no.: 2000-558 Modular TOPJOB®S connector; modular; for jumper contact slot; 8-pole	2000-558
	Item no.: 2000-559 Modular TOPJOB®S connector; modular; for jumper contact slot; 9-pole	2000-559
	Item no.: 2000-560 Modular TOPJOB®S connector; modular; for jumper contact slot; 10-pole	2000-560
	Item no.: 2009-174 Test plug adapter; for 4 mm Ø test plugs; for testing TOPJOB®S rail-mounted terminal blocks	2009-174
	Item no.: 2009-182 Testing tap; for max. 2.5 mm ² ; tool-free connection for individual test wires 0.08 - 2.5 mm	2009-182
ferrule		
	Item no.: 216-241 Ferrule; Sleeve for 0.5 mm ² / 20 AWG; insulated; electro-tin plated; electrolytic copper; gastight crimped; acc. to DIN 46228, Part 4/09.90	216-241
	Item no.: 216-242 Ferrule; Sleeve for 0.75 mm ² / 18 AWG; insulated; electro-tin plated; electrolytic copper; gastight crimped; acc. to DIN 46228, Part 4/09.90	216-242
	Item no.: 216-243 Ferrule; Sleeve for 1 mm ² / AWG 18; insulated; electro-tin plated; electrolytic copper; gastight	216-243



crimped; acc. to DIN 46228, Part 4/09.90

Coding



Item no.: 2020-100 2020-100
Carrier with 6 coding pins; for coding of female plugs; for carrier terminal blocks

General accessories



Item no.: 2000-121 2000-121
Adaptor



Item no.: 2020-161 2020-161
Start module for 1-conductor female connector; with integrated end plate; 1.5 mm²; 1-pole



Item no.: 2020-164 2020-164
Start module for 1-conductor female connector; with integrated end plate; 1.5 mm²; 1-pole



Item no.: 2020-167 2020-167
Start module for 1-conductor female connector; 1.5 mm²; 1-pole



Item no.: 2020-181 2020-181
End module for 1-conductor female connector; 1.5 mm²; 1-pole



Item no.: 2020-184 2020-184
End module for 1-conductor female connector; 1.5 mm²; 1-pole



Item no.: 2020-187 2020-187
End module for 1-conductor female connector; 1.5 mm²; 1-pole



Item no.: 2020-261 2020-261
Start module for 2-conductor female connector; with integrated end plate; 1.5 mm²; 1-pole



Item no.: 2020-264 2020-264
Start module for 2-conductor female connector; with integrated end plate; 1.5 mm²; 1-pole



Item no.: 2020-267 2020-267
Start module for 2-conductor female connector; 1.5 mm²; 1-pole



Item no.: 2020-281 2020-281
End module for 2-conductor female connector; 1.5 mm²; 1-pole



Item no.: 2020-284 2020-284
End module for 2-conductor female connector; 1.5 mm²; 1-pole



Item no.: 2020-287 2020-287
End module for 2-conductor female connector; 1.5 mm²; 1-pole

Downloads

Documentation

Bid Text

2020-5317/102-000	doc 26.6 kB	Download
-------------------	----------------	----------

Additional Information

	pdf	Download
--	-----	----------



2.1 MB

CAD/CAE - Smart Data

CAD data

3D Download 2020-5317/102-000

URL

Download

Subject to changes.
